

Panasonic

THE HEALTHIEST CHOICE



By using the energy recovery ventilator, outdoor air will be filtered and ventilated indoors. It will also effectively filter the indoor polluted air to outdoors "Green" lifestyle is achieved and you and your family's health are taken care of.



FY-E15DZ1

Pre
Filter

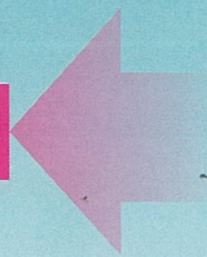

With energy recovery ventilator,
nature is inside your home.



Panasonic Energy Recovery Ventilator

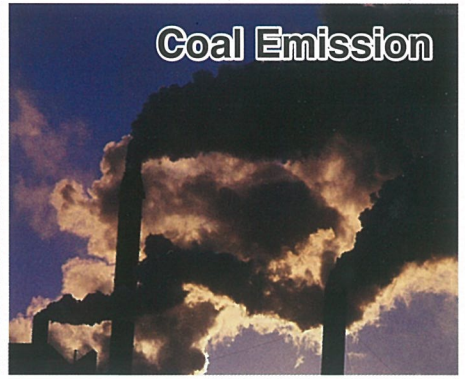
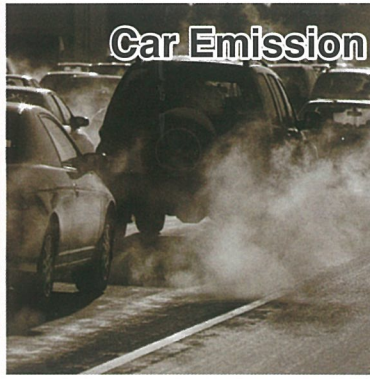
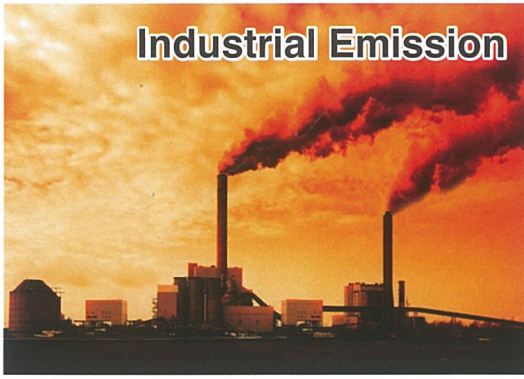

Outdoor Pollution

Quantity of automobile in China is ranked no.2 in the world

120 million cars

Coal consumption

3.6 tons

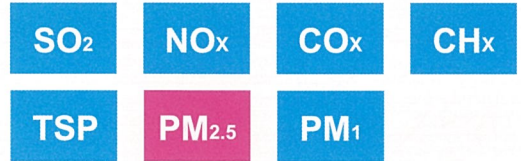

Data based on Chinese Govt Traffic Control/Energy Department

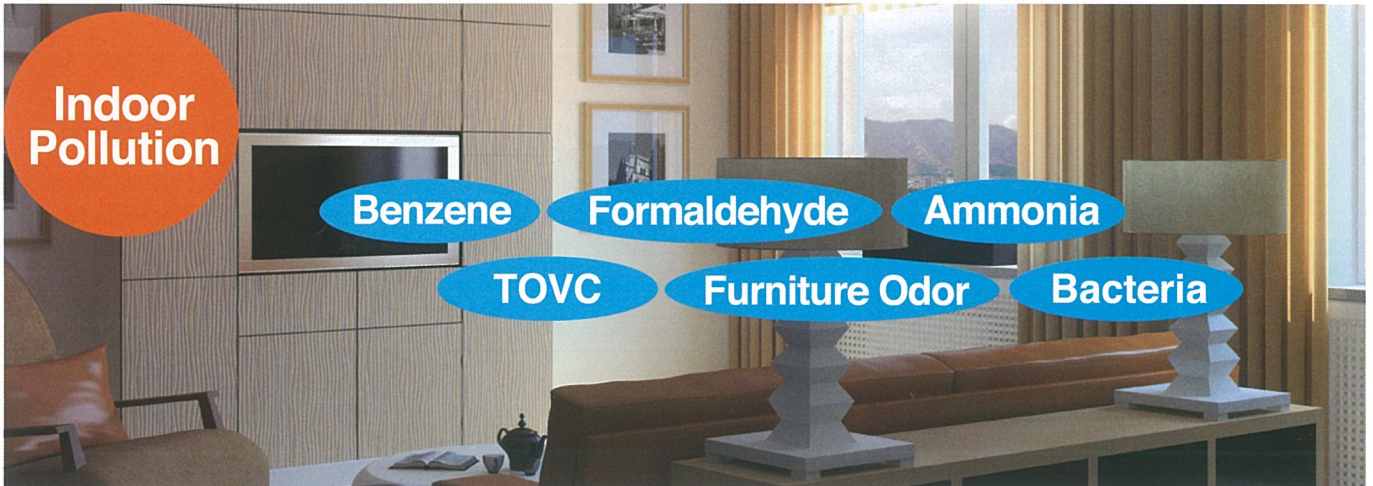

Air pollution of major cities of China in 1st half of 2013

Over 60% of the time Beijing's air quality did not meet the standard air quality level

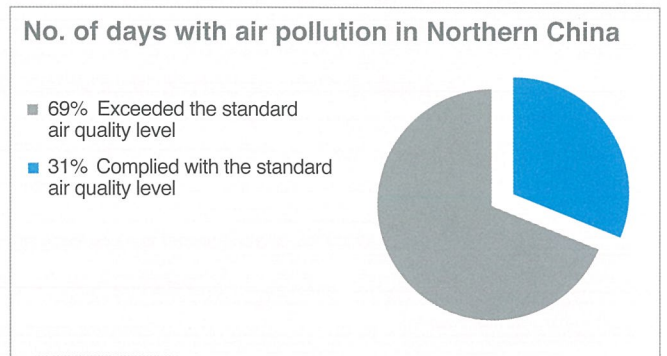
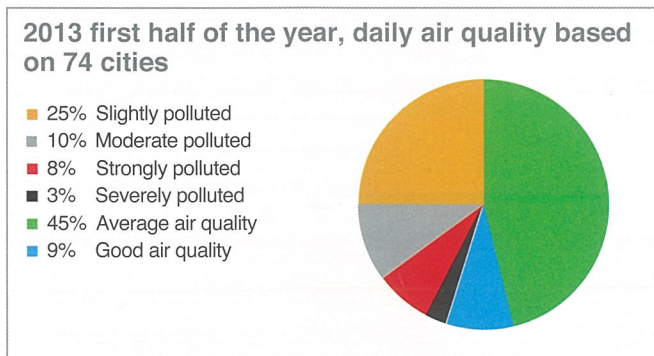

Data based on China's Environmental Dept.

Standard model

- FY-E15DZ1
- FY-E15DZ1L
- FY-E25DZ1
- FY-E25DZ1L
- FY-E35DZ1
- FY-E35DZ1L
- FY-E50DZ1
- FY-E50DZ1L

Panasonic's innovative slim design

NEW



Model 15, 25



3 easy and convenient innovations

With 24-hour continuous ventilation, fresh air will circulate around the whole house. As ventilation with energy recovery ventilator, energy loss of air conditioning (including sensible heat and latent heat) is minimized. This provides a highly efficient, energy saving ventilated environment.

Enjoy Double Comfort with Interlocking Air Conditioning

The newly developed energy recovery ventilator can interlock air conditioning. It allows you to enjoy both fresh air and comfortable temperature.

Convenient Installation and Maintenance

Side maintenance opening is only 450 x 450mm, that saves installation space and allows easy inspection for filter, element, as well as terminal box.

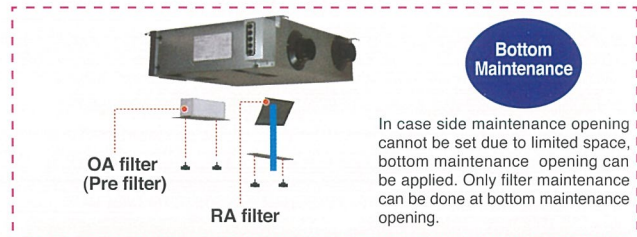
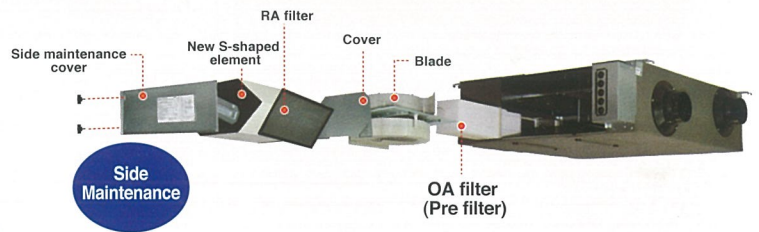
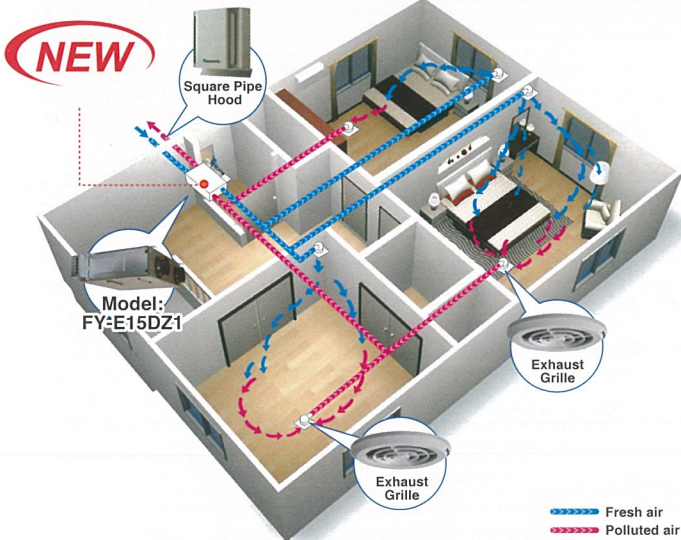

Inside of Heat Exchange Core (diagram) Winter

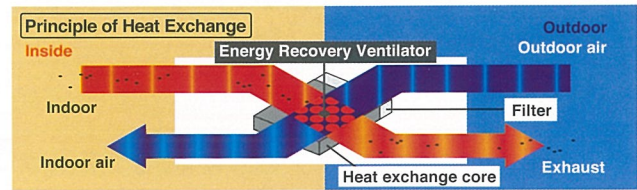
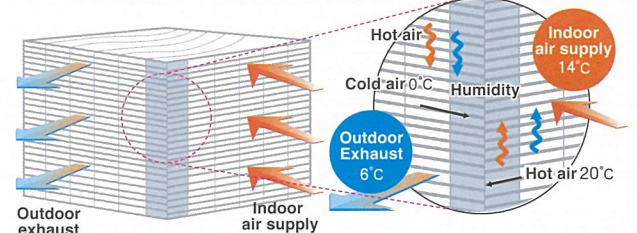

Multiple ways of installation, horizontally hanging or vertically mounting

The new energy recovery ventilator of the heat exchange device can be installed onto the ceiling or wall, so from now on installation and maintenance will not be a problem

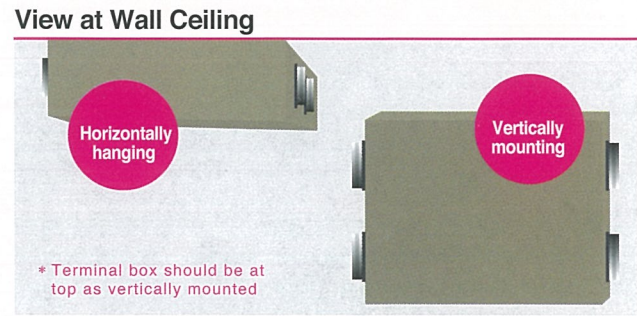



Whole House Filled With Clean Air

Slim Energy Recovery Ventilator

Slim design, ventilation with filtration

Standard Series

24-hour continuous

With 24-hour continuous ventilation, stale air is exhausted while fresh air is enters into the house. Circulation of fresh air throughout the whole house is maintained.

Structure Diagram



Recommended to change filter every year and clean every month

Pre Filter

Standard Series

Filter outdoor large dust particles and insects

Life time of filter is subject to usage environment

Pre Filter (Standard Type Energy Recovery Ventilator)

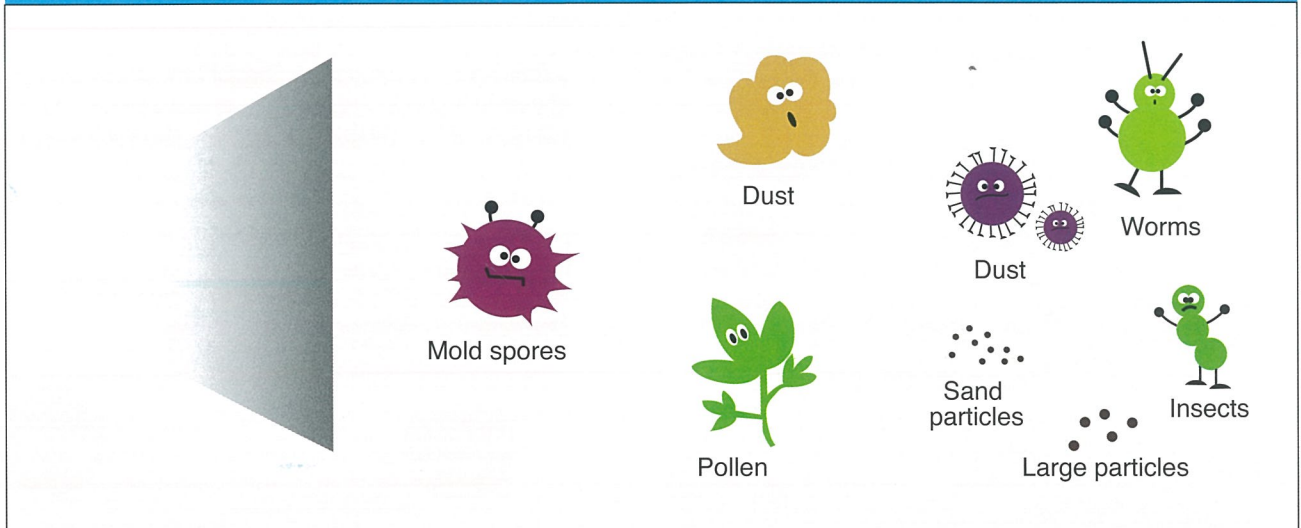

Dust particle diameter 1 μm

10 μm

100 μm

1 mm

Considerate Design for Extra Saving

Cost Efficient

Slim and Quiet

Slim design of the newly developed models enables easy installation in narrow space.

FY-E25DZ1

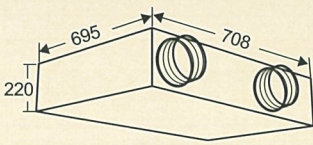

Unit: mm

Bypass Ventilation for Speedy Exhaust of Polluted Air

Diversion damper is equipped for Bypass Ventilation. Return airflow (RA) is greater than supply airflow (SA) allowing speedy exhaust of indoor polluted air. By using bypass ventilation during season change, it will be more comfortable and energy saving.

* In case outdoor air is highly polluted, it is not recommended to use bypass ventilation. It may cause negative pressure that polluted outdoor air may ingress into the houses through the gaps at the doors and windows.

[Heat Exchange Mode]

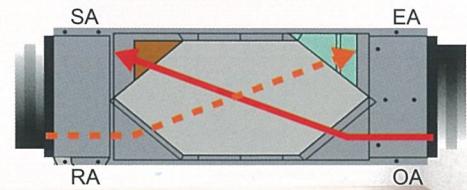

[Normal Ventilator Model]

■ Bypass ventilation

Diversion Damper

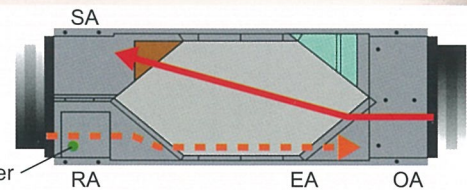

Long Term Cost Comparison

Long term cost comparison for Panasonic ventilation fan and energy recovery ventilator

Unit: Dollar/year

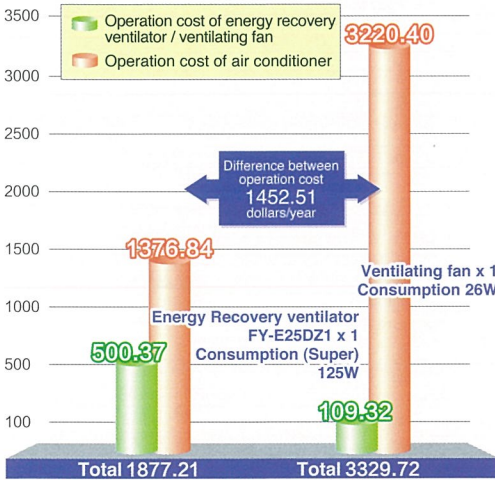

Explanation of Normal Ventilation

(Bypass Ventilation)

OA-SA side: Same as Heat Exchange Mode, pass through filter and element
RA-EA side: Diversion damper open, partially pass through element

Highly efficient energy recovery reduce energy loss during ventilation, that achieve energy saving
Example: FY-E15DZ1

Summer Utilize energy of indoor return cool air to cool down outdoor air before intake to indoor, indoor cool loss is reduced

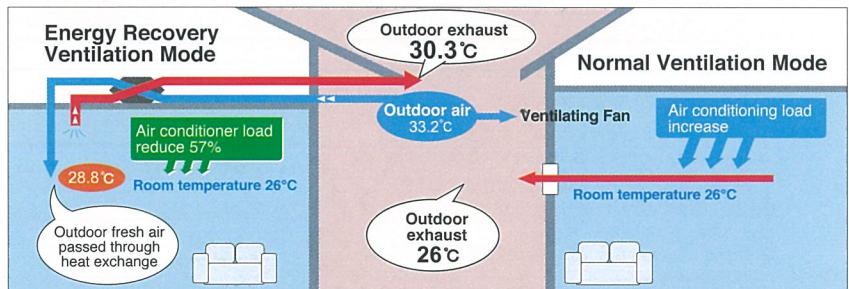

Based on the following condition

[Test condition]

Location: Beijing area

- Indoor : Cooling 26°C (RH50%) Heating 20°C (RH50%)
- Outdoor : Cooling 33.2°C (RH59%) Heating -10°C (RH45%)
- Ventilation air volume: 200m² x 2.5m x 0.5 times/h = 250m³/h
- Air conditioner operation time:
Summer 24hrs/day x 122 days = 2928hrs (June to September)
Winter 24hrs/day x 120 days = 2880hrs (November 15th to March 15th)
- Electricity charge: 0.48 dollars/KW.h

※ Since energy recovery ventilator can reduce ventilation load, cooling and heating load of air conditioner are decreased subsequently. Thus the initial equipment cost for air conditioner can be possibly reduced.

Winter Utilize energy of indoor return warm air to heat up outdoor air before intake to indoor, indoor heat loss is reduced

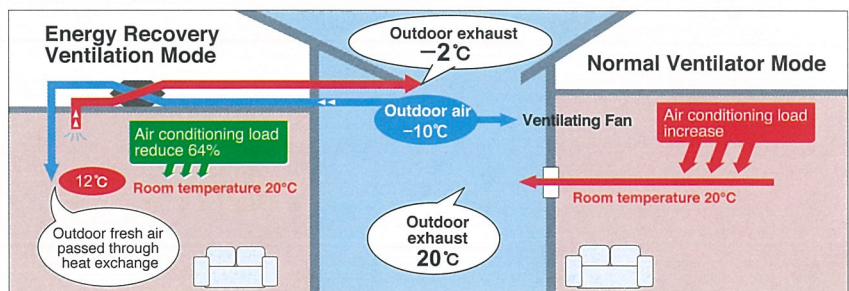

Product Specification



FY-E15DZ1 FY-E15DZ1L

Product Dimension (Unit: mm)

No.	Item	Qty	Material
1	Cover	1	Galvanized Steel
2	Air Outlet	4	ABS
3	Wheel	2	PP
4	Power Unit	1	
5	Heat Exchange Core	1	Paper and Resin
6	Outdoor Air Filter	1	Non-woven Cloth
7	Return Filter	1	
8	Hanging Bracket	4	Galvanized Steel
9	Power Box	1	Galvanized Steel

• FY-E15DZ1

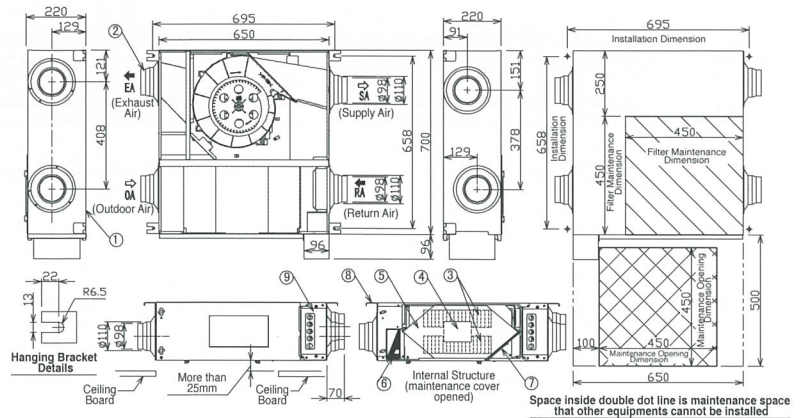

Static Pressure-Air Volume Performance Curve

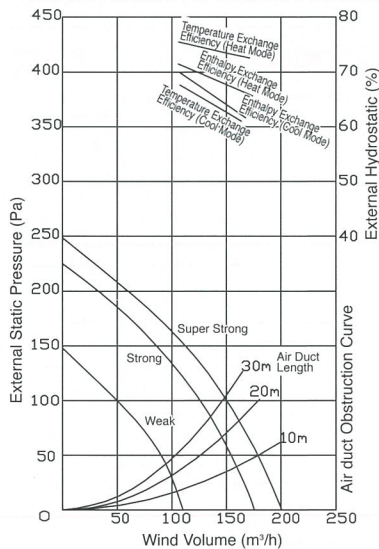

The duct length in the diagram is the equivalent straight duct length with friction coefficient $\lambda = 0.02$

1. Applicable duct diameter: $\varnothing 100$.
2. The above dimensions exclude the thickness of insulation material.
3. Noise measured at 1.5m apart from lower center of the product.
4. Noise level is the value measured at sound proof test room. Noise level will be higher subject to actual surrounding environment.

• FY-E15DZ1L

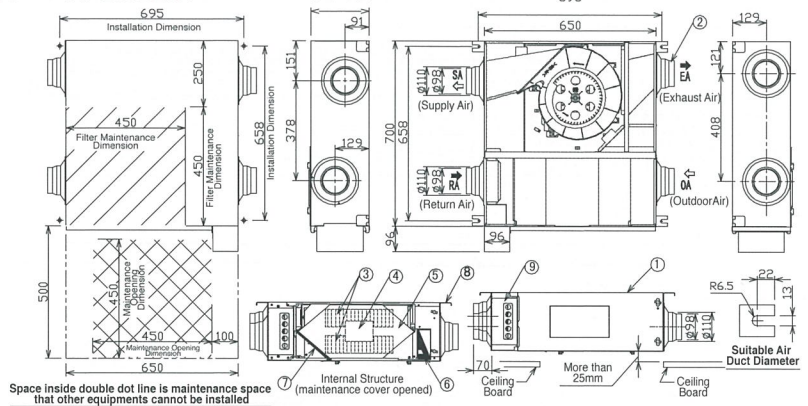

FY-E15DZ1 FY-E15DZ1L

		Strong
Heat Exchange	Static Pressure [Pa]	100
	Air Volume [m ³ /h]	150
	Noise [dB]	28
	Power [W]	85
Normal Ventilation Air Volume [m ³ /h]	SA (supply-air)	120
	EA (exhaust-air)	180
Heat Exchange Effectiveness [%]	Cooling	63
	Heating	75
Enthalpy Exchange Effectiveness [%]	Cooling	65
	Heating	68
Duct Size (mm)		$\varnothing 100$
Product Size (mm)		650 x 700 x 220

General Information

Installation Diagram

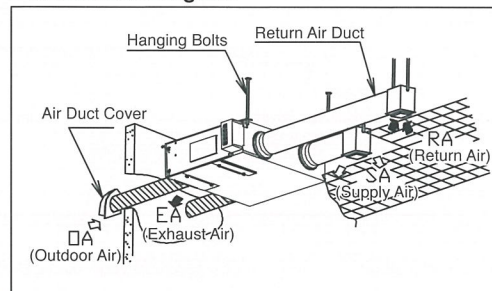

Maintenance Opening Size

Maintain heat exchange element and filter according to operation manual, maintenance opening should be set.



FY-E25DZ1

FY-E25DZ1L

● Product Dimension (Unit: mm)

No.	Item	Qty	Material
1	Cover	1	Galvanized Steel
2	Air Outlet	4	ABS
3	Wheel	2	PP
4	Power Unit	1	
5	Heat Exchange Core	1	Paper and Resin
6	Outdoor Air Filter	1	Non-woven Cloth
7	Return Filter	1	
8	Hanging Bracket	4	Galvanized Steel
9	Power Box	1	Galvanized Steel

● FY-E25DZ1

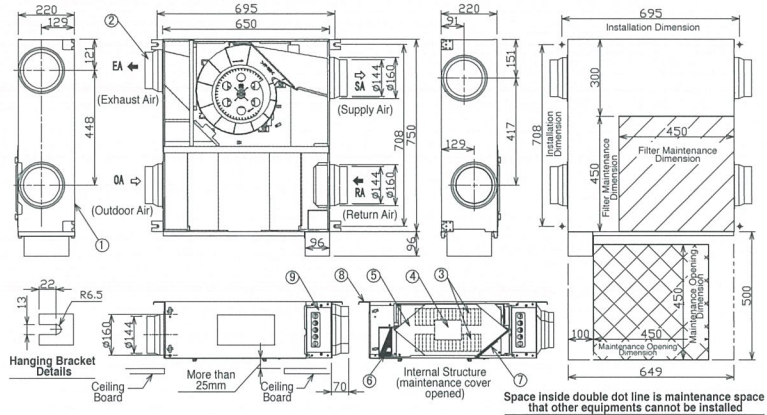

Space inside double dot line is maintenance space that other equipments cannot be installed

■ Static Pressure-Air Volume Performance Curve

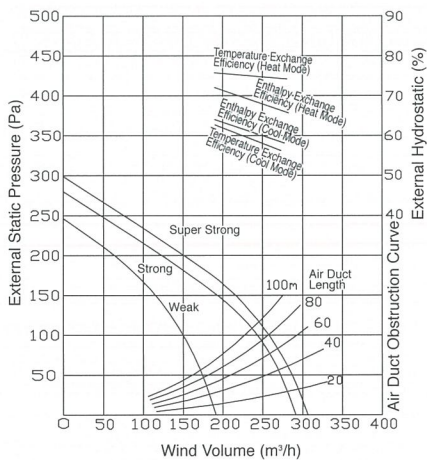

The duct length in the diagram is the equivalent straight duct length with friction coefficient $\lambda = 0.02$

1. Applicable duct diameter: $\varnothing 150$.
2. The above dimensions exclude the thickness of insulation material.
3. Noise measured at 1.5m apart from lower center of the product.
4. Noise level is the value measured at sound proof test room. Noise level will be higher subject to actual surrounding environment.

● FY-E25DZ1L

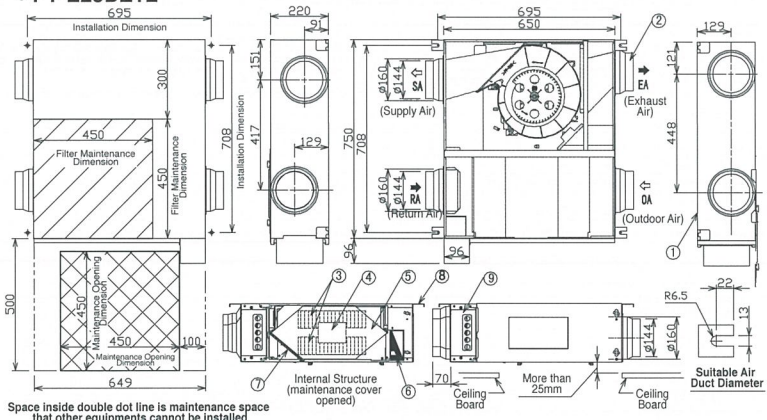

Space inside double dot line is maintenance space that other equipments cannot be installed

FY-E25DZ1
FY-E25DZ1L

		Strong
Heat Exchange	Static Pressure [Pa]	115
	Air Volume [m ³ /h]	250
	Noise [dB]	32
	Power [W]	125
Normal Ventilation Air Volume [m ³ /h]	SA (supply-air)	230
	EA (exhaust-air)	280
Heat Exchange Effectiveness [%]	Cooling	58
	Heating	73
Enthalpy Exchange Effectiveness [%]	Cooling	60
	Heating	67
Duct Size (mm)		$\varnothing 150$
Product Size (mm)		650 x 750 x 220

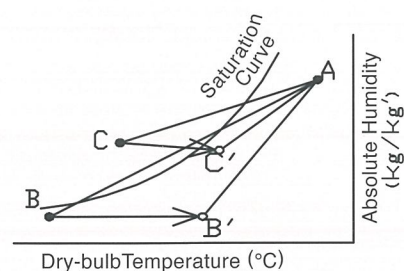

Caution

1. Heat insulation is required for the duct connecting to external.
2. In cold region or under strong wind velocity, outdoor air may ingress into indoor.
3. When installing the air ducts from the exterior to interior, air ducts needs to be slanted to avoid rain water from entering.
4. As shown in the diagram, if the air temperatures differ greatly, A being a high temperature and B being a low temperature, using the heat exchange ventilator the device cannot achieve the optimum level- saturation curve C. In this case, the device will become too cold. To avoid this situation, before using the device, it is recommended that the low temperature B is heated in order to achieve C.

Product Specification



FY-E35DZ1 FY-E35DZ1L



Product Dimension (Unit: mm)

No.	Item	Qty	Material
1	Cover	1	Galvanized Steel
2	Air Outlet	4	ABS
3	Wheel	2	PP
4	Power Unit	1	
5	Heat Exchange Core	1	Paper and Resin
6	Outdoor Air Filter	1	Non-woven Cloth
7	Return Filter	1	
8	Hanging Bracket	4	Galvanized Steel
9	Power Box	1	Galvanized Steel

• FY-E35DZ1

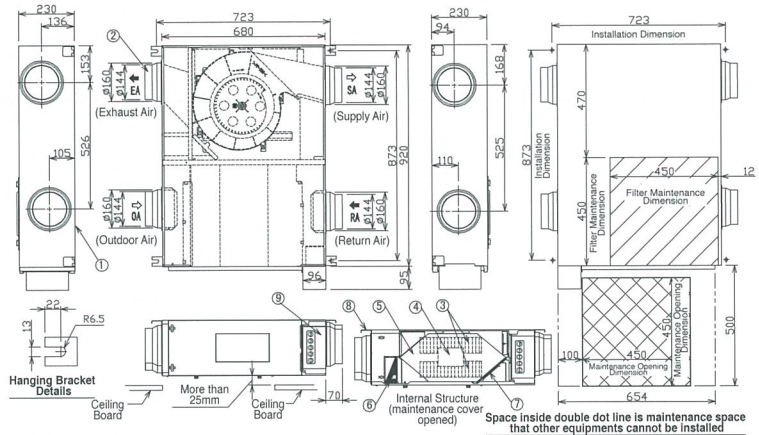

Static Pressure-Air Volume Performance Curve

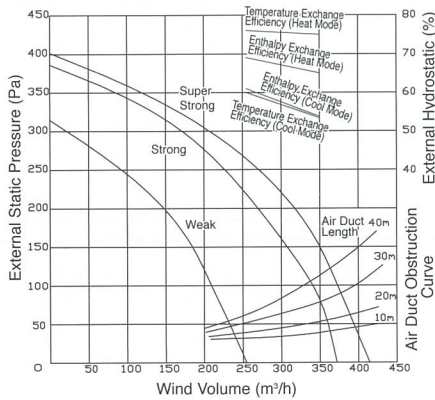

The duct length in the diagram is the equivalent straight duct length with friction coefficient $\lambda = 0.02$

1. Applicable duct diameter: $\varnothing 150$.
2. The above dimensions exclude the thickness of insulation material.
3. Noise measured at 1.5m apart from lower center of the product.
4. Noise level is the value measured at sound proof test room. Noise level will be higher subject to actual surrounding environment.

• FY-E35DZ1L

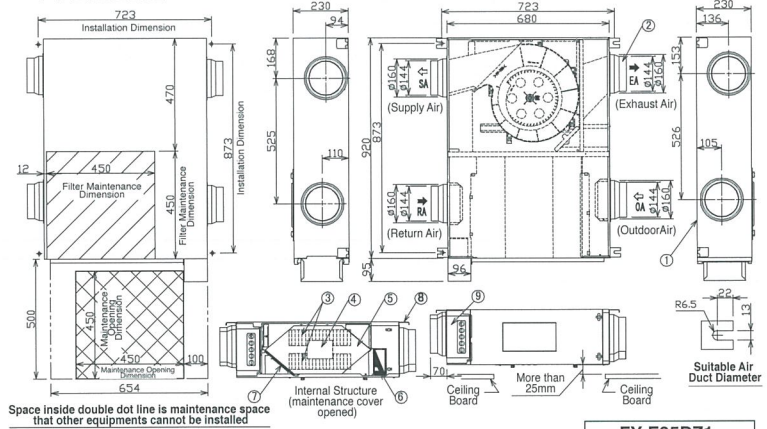

Space inside double dot line is maintenance space that other equipments cannot be installed

FY-E35DZ1 FY-E35DZ1L

		Strong	
Heat Exchange	Static Pressure [Pa]	150	
	Air Volume [m ³ /h]	350	
	Noise [dB]	36	
	Power [W]	225	
Normal Ventilation Air Volume [m ³ /h]	SA (supply-air)	340	
	EA (exhaust-air)	390	
Heat Exchange Effectiveness [%]	Cooling	54	
	Heating	75	
Enthalpy Exchange Effectiveness [%]	Cooling	56	
	Heating	65	
Duct Size (mm)		$\varnothing 150$	
Product Size (mm)		680 x 920 x 230	

General Information

Installation Diagram

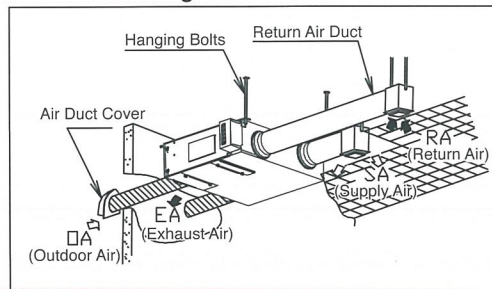

Maintenance Opening Size

Maintain heat exchange element and filter according to operation manual, maintenance opening should be set.



FY-E50DZ1 FY-E50DZ1L



Product Dimension (Unit: mm)

No.	Item	Qty	Material
1	Cover	1	Galvanized Steel
2	Air Outlet	4	ABS
3	Wheel	2	PP
4	Power Unit	1	
5	Heat Exchange Core	2	Paper and Resin
6	Outdoor Air Filter	2	Non-woven Cloth
7	Return Filter	2	
8	Hanging Bracket	4	Galvanized Steel
9	Power Box	1	Galvanized Steel

• FY-E50DZ1

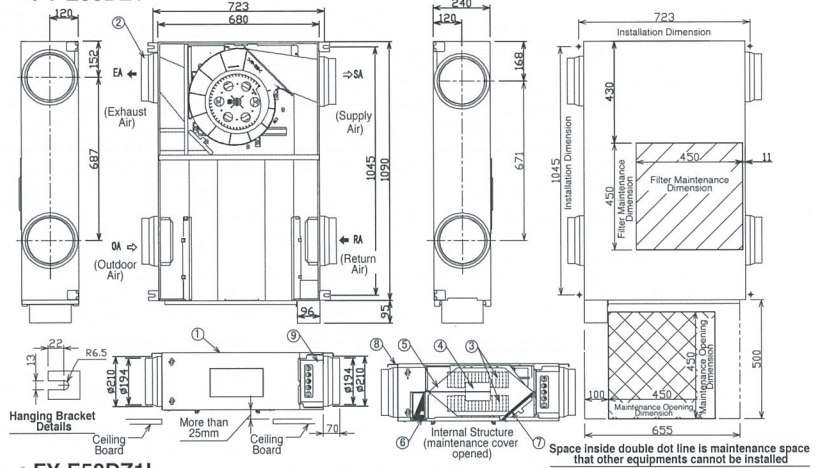

• FY-E50DZ1L

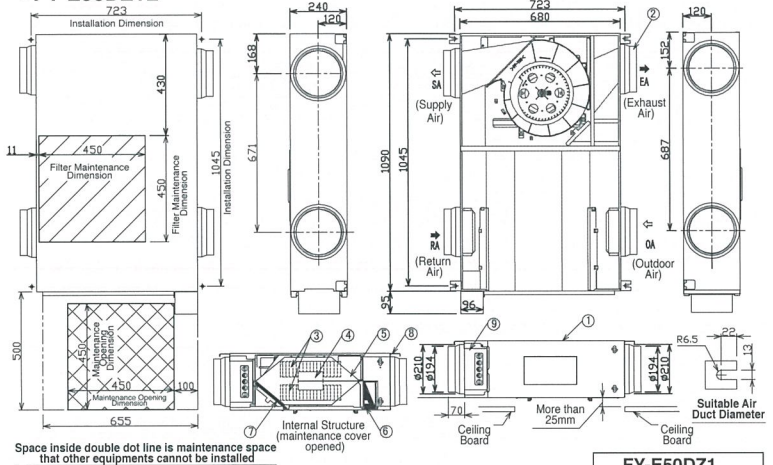

Static Pressure-Air Volume Performance Curve

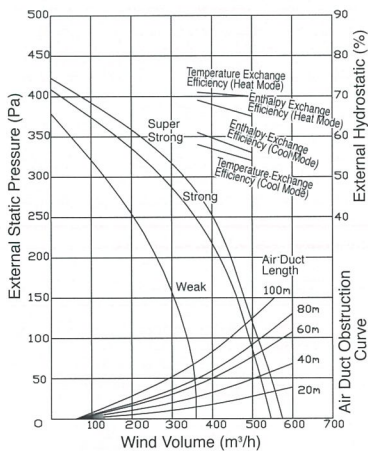

The duct length in the diagram is the equivalent straight duct length with friction coefficient $\lambda = 0.02$

1. Applicable duct diameter: $\varnothing 200$.
2. The above dimensions exclude the thickness of insulation material.
3. Noise measured at 1.5m apart from lower center of the product.
4. Noise level is the value measured at sound proof test room. Noise level will be higher subject to actual surrounding environment.

		FY-E50DZ1 FY-E50DZ1L
		Strong
Heat Exchange	Static Pressure [Pa]	120
	Air Volume [m ³ /h]	500
	Noise [dB]	37
	Power [W]	315
Normal Ventilation Air Volume [m ³ /h]	SA (supply-air)	490
	EA (exhaust-air)	540
Heat Exchange Effectiveness [%]	Cooling	54
	Heating	70
Enthalpy Exchange Effectiveness [%]	Cooling	56
	Heating	65
Duct Size (mm)		$\varnothing 200$
Product Size (mm)		680 x 1090 x 240

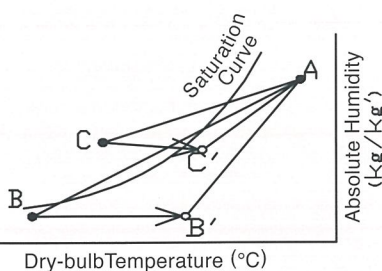

Caution

1. Heat insulation is required for the duct connecting to external.
2. In cold region or under strong wind velocity, outdoor air may ingress into indoor.
3. When installing the air ducts from the exterior to interior, air ducts needs to be slanted to avoid rain water from entering.
4. As shown in the diagram, if the air temperatures differ greatly, A being a high temperature and B being a low temperature, using the heat exchange ventilator the device cannot achieve the optimum level- saturation curve C. In this case, the device will become too cold. To avoid this situation, before using the device, it is recommended that the low temperature B is heated in order to achieve C.



Panasonic[®]
Panasonic Ecology Systems Co., Ltd.

- Specifications are subject to change without prior notice.
- Actual colors may vary slightly from those shown.

CATALOG NO: P-THERV001
Printed in Hong Kong 02.15